

лялька  
bábika

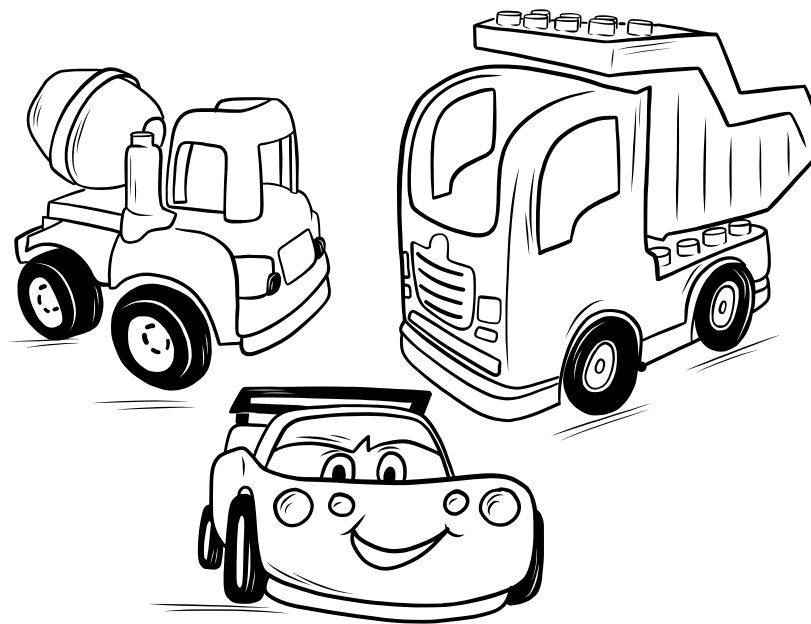

машина  
auto

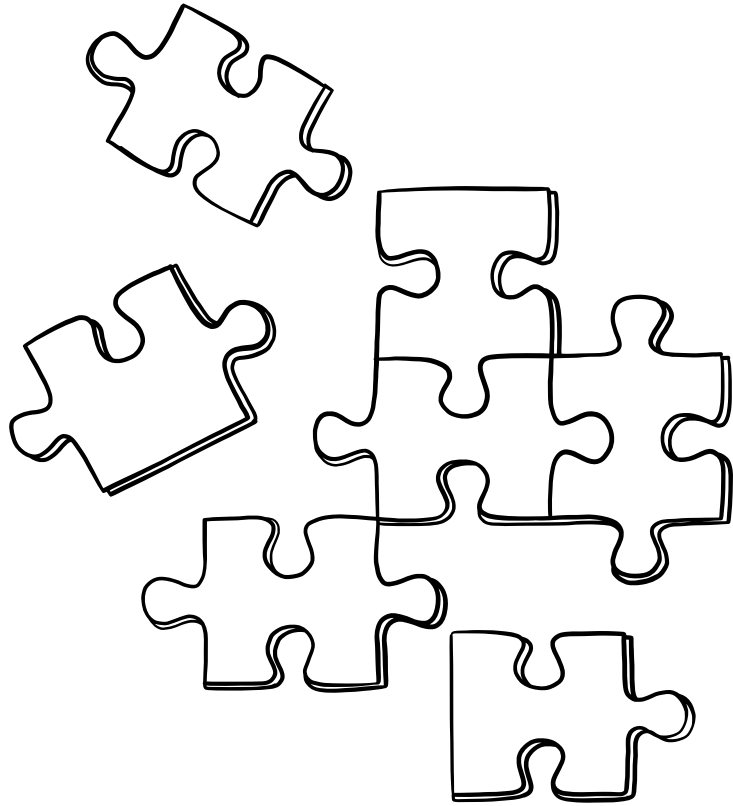

пазл  
puzzle

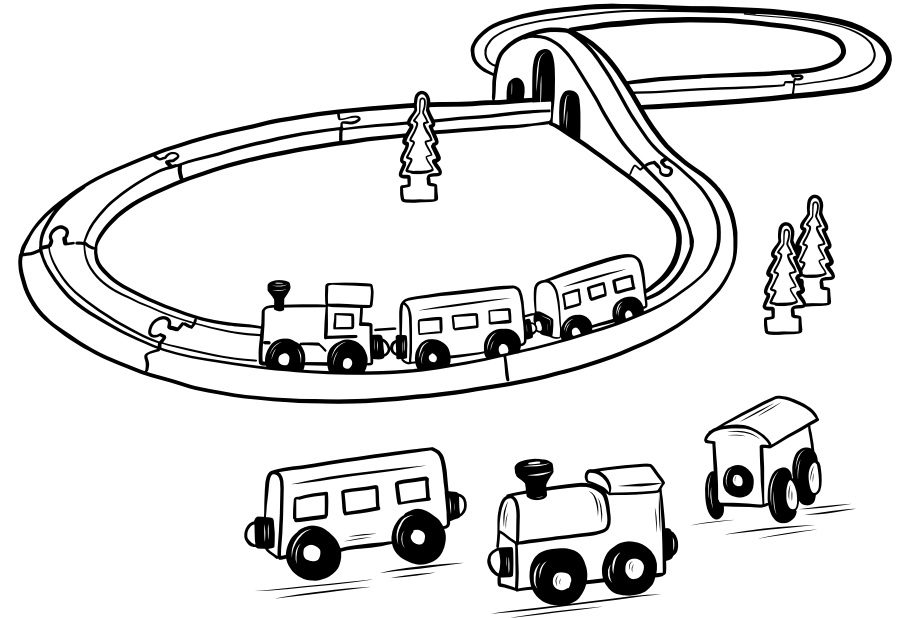

поїзд  
vlak

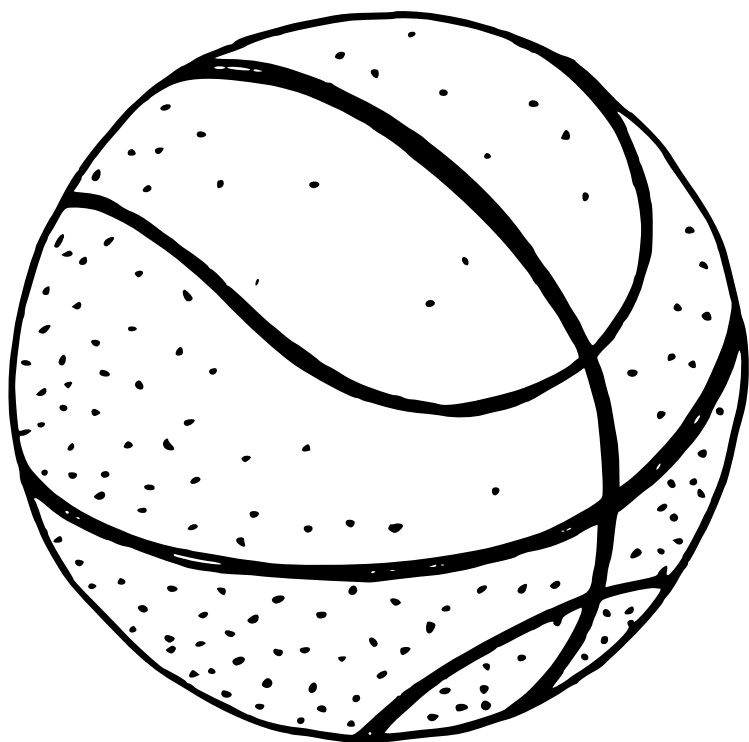

м'яч  
lopta



розмальовки  
omaľovánky



напій  
pitie

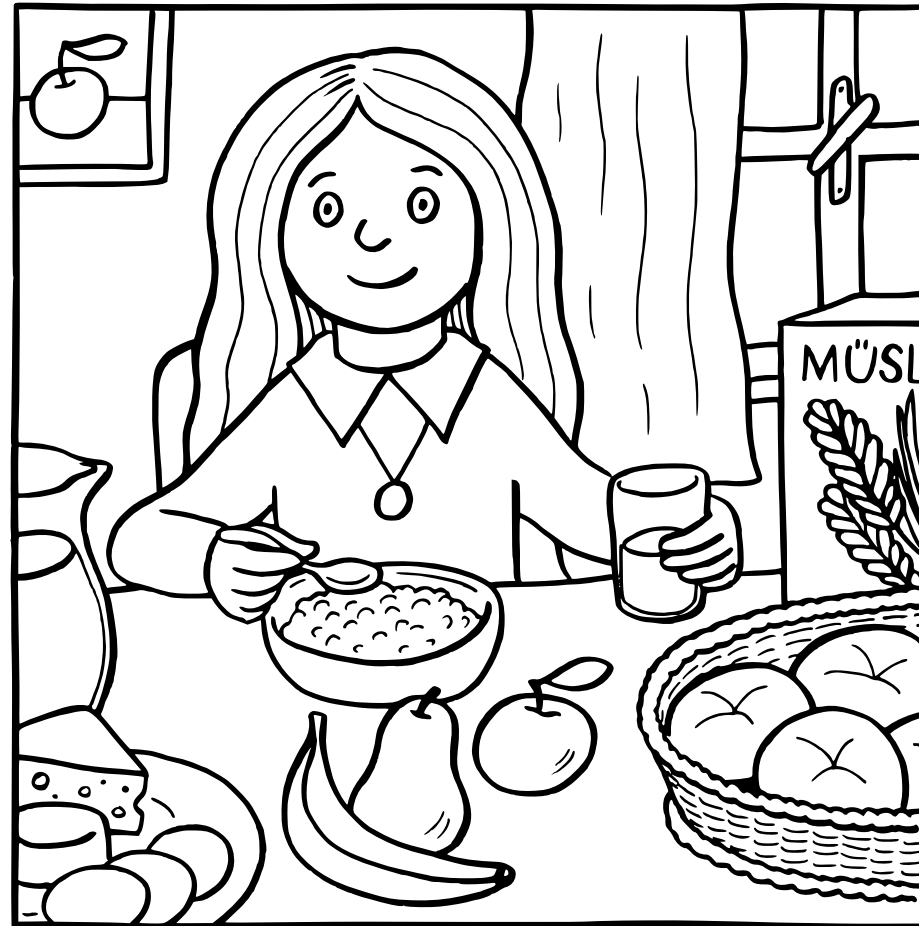

сніданок  
raňajky



перекуска  
desiata, olovrant

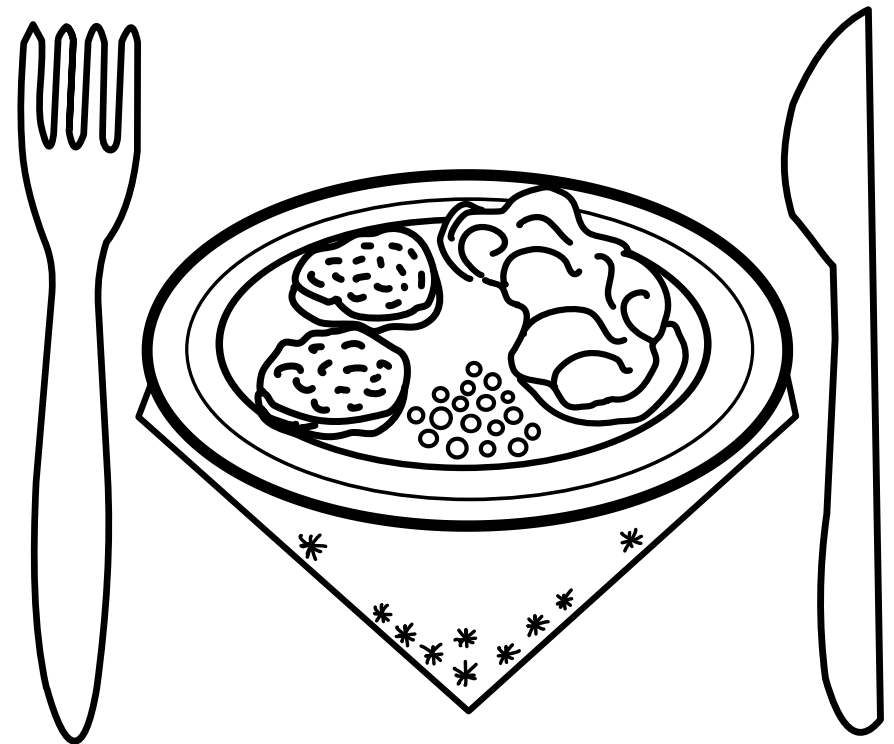

обід  
obed

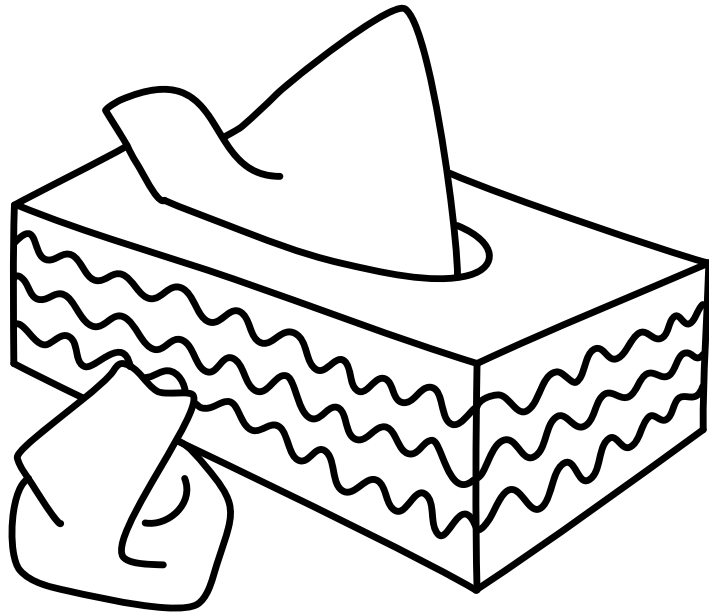

НОСОВА ХУСТИНКА  
vreckovka



ЛІЖКО  
postel'



туалет  
záchod



подорож  
výlet



сад  
záhrada

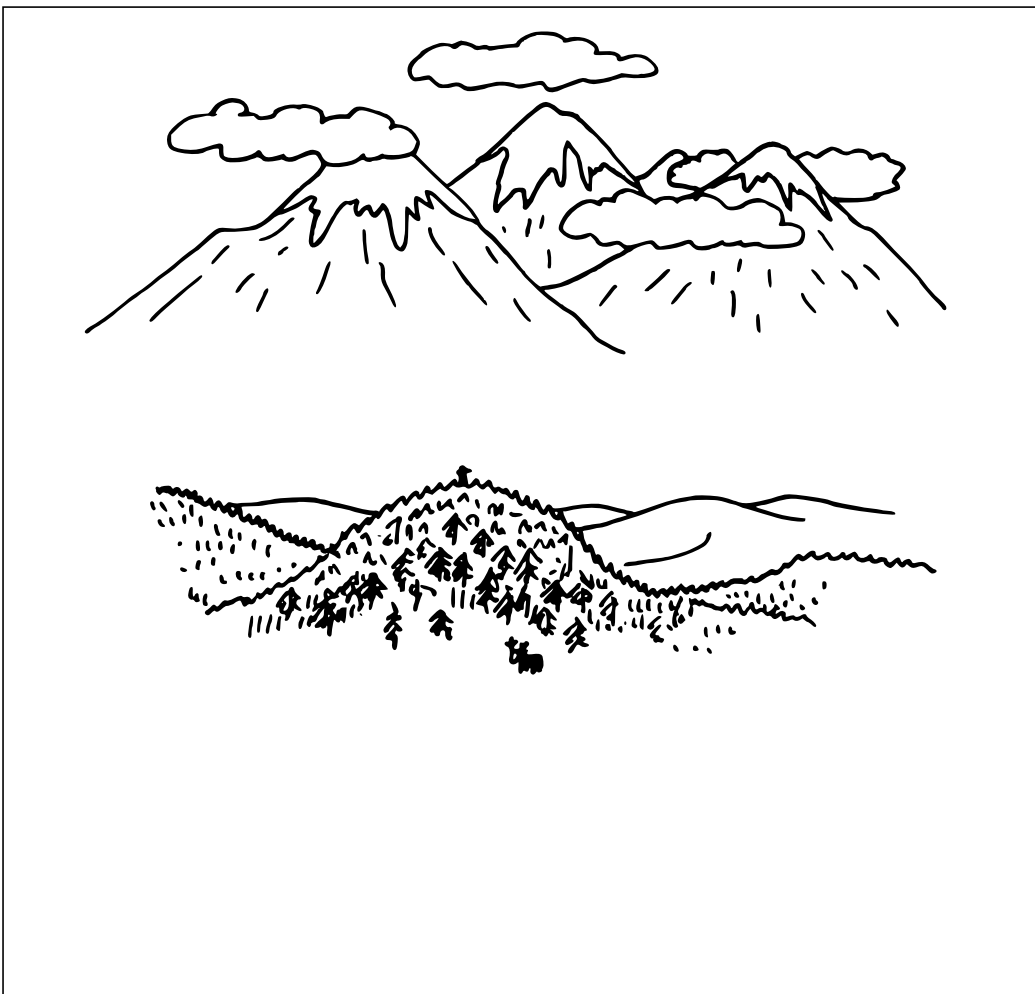

гори  
hory





кататися на  
ковзанах  
korčuľovať sa



чистити зуби  
umývať si zuby



робити вправи  
свічіť



У мене болить  
живіт.  
Bolí ma brucho.

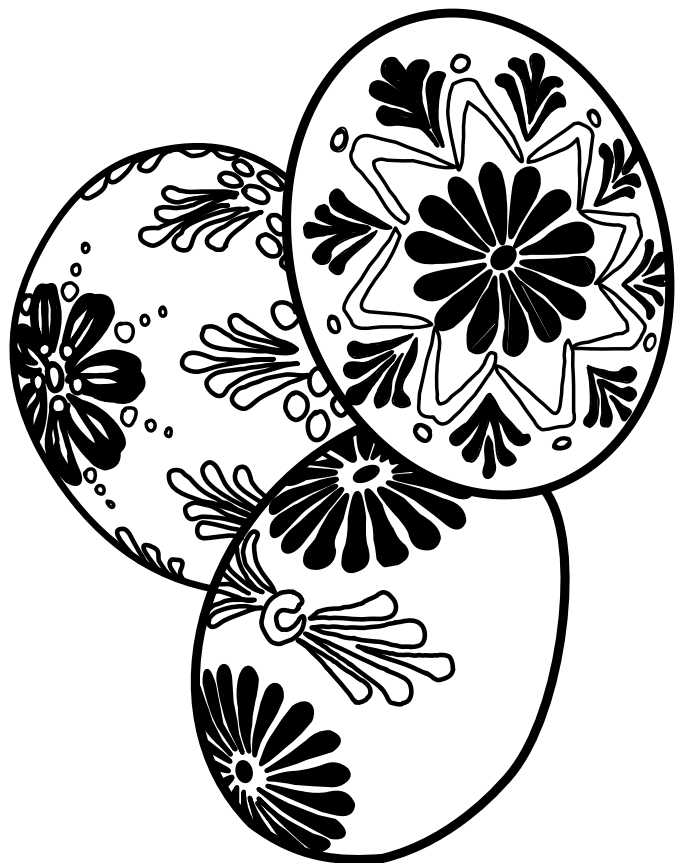

писанка  
kraslica



зайчик  
zajačik

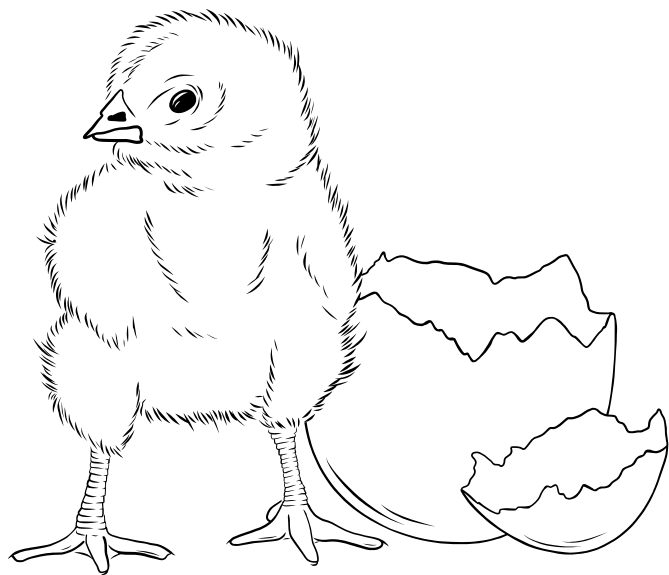

курчатко  
kuriatko

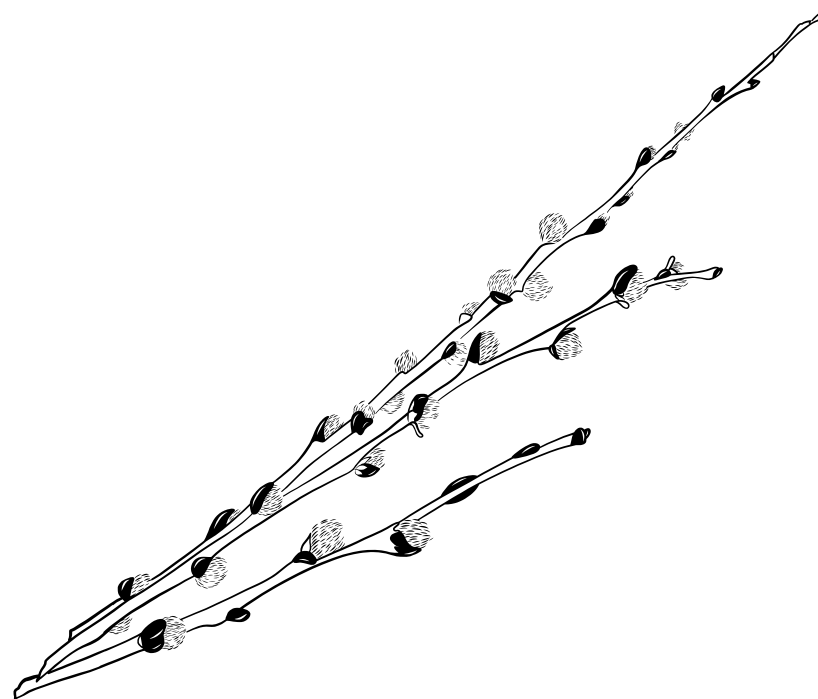

котики (цвіт верби)  
bahniatka (kvety  
vrby rakytovej)



баранець  
baranček



примула  
prvosienka



ТЮЛЬПАНИ  
tulipány

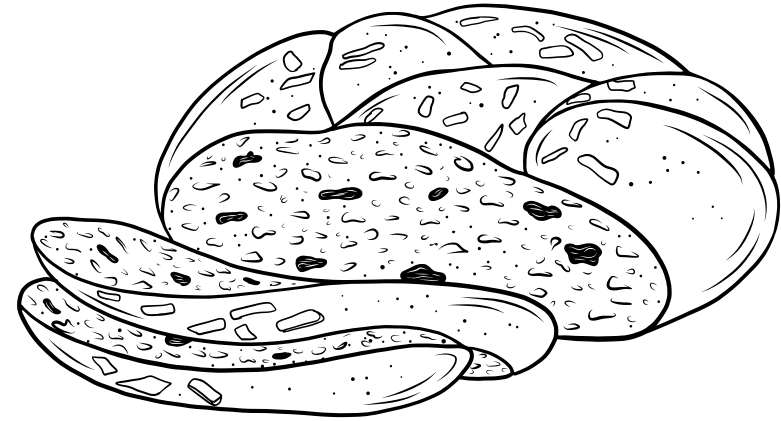

пасочка  
mazanec



мак  
mak



кульбаба  
rúrava



бузок  
orgován



СОНЯШНИК  
slniečnica



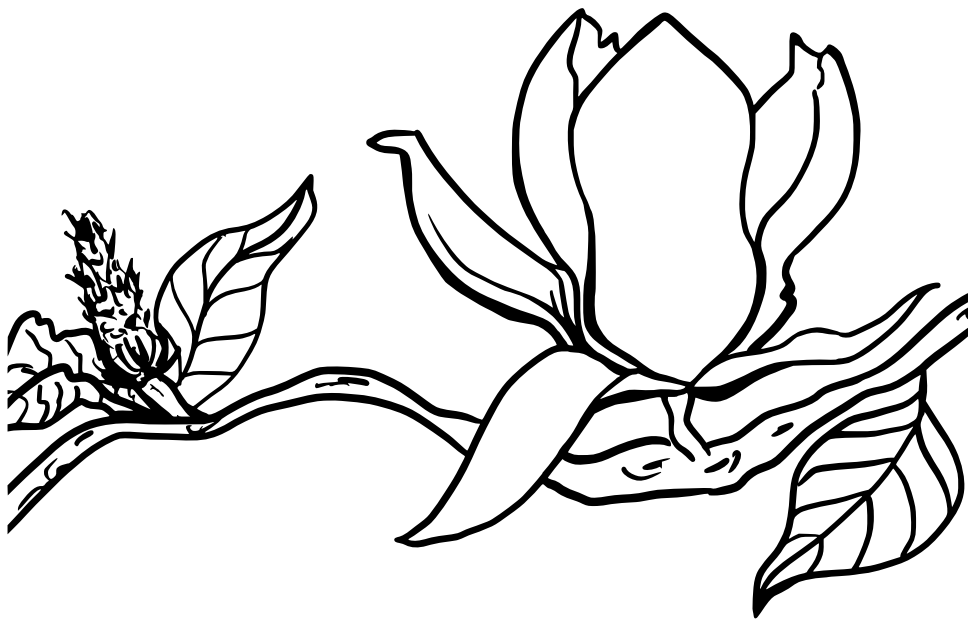

магнолія  
magnólia

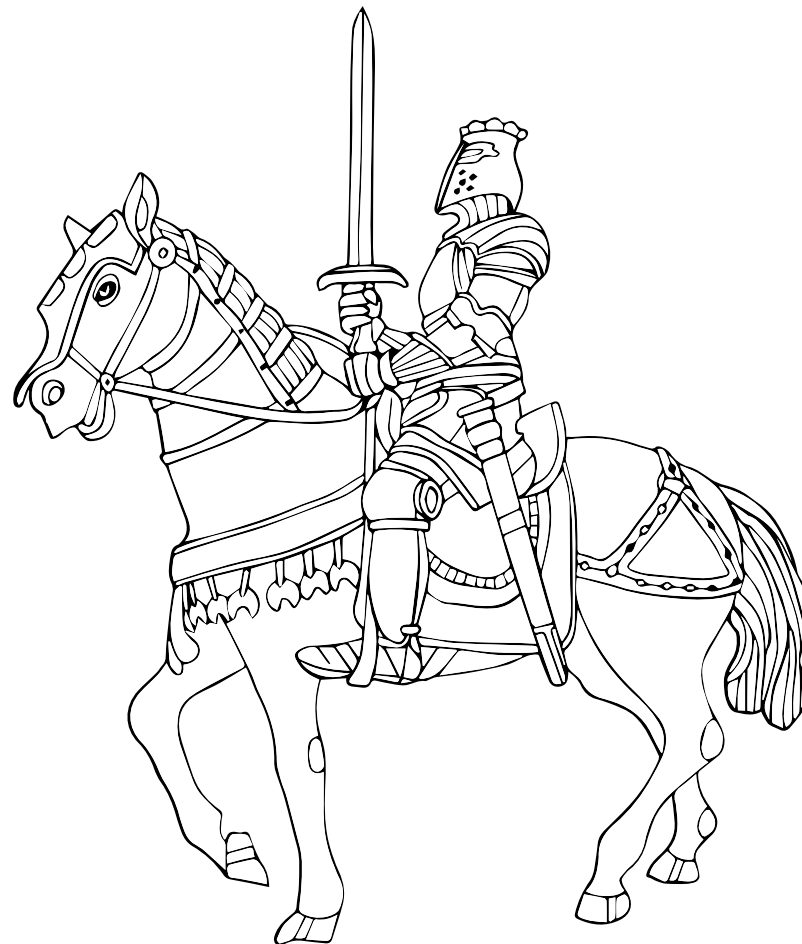

хоробрий лицар  
statočný rytier



прекрасна  
принцеса  
krásna princezná



король  
král'

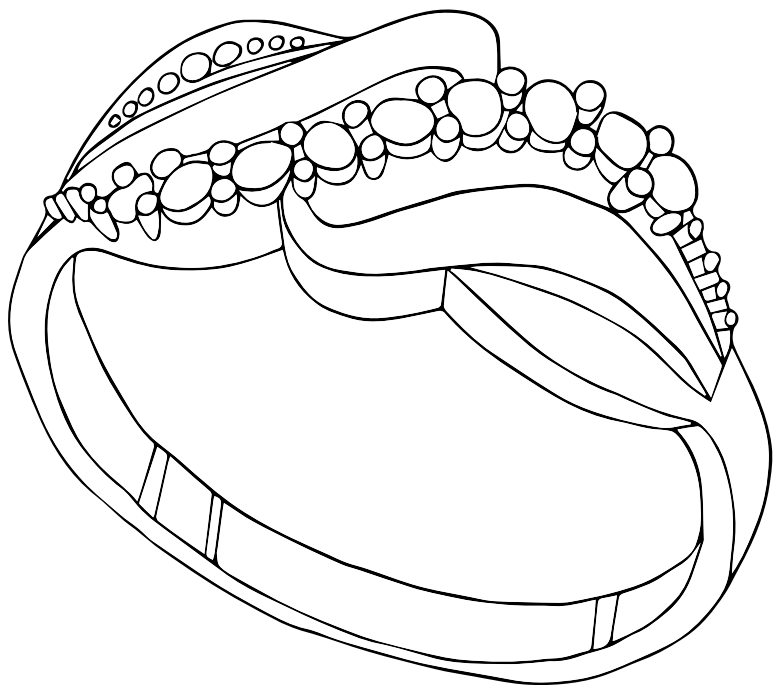

золотий перстень  
zlatý prsteň

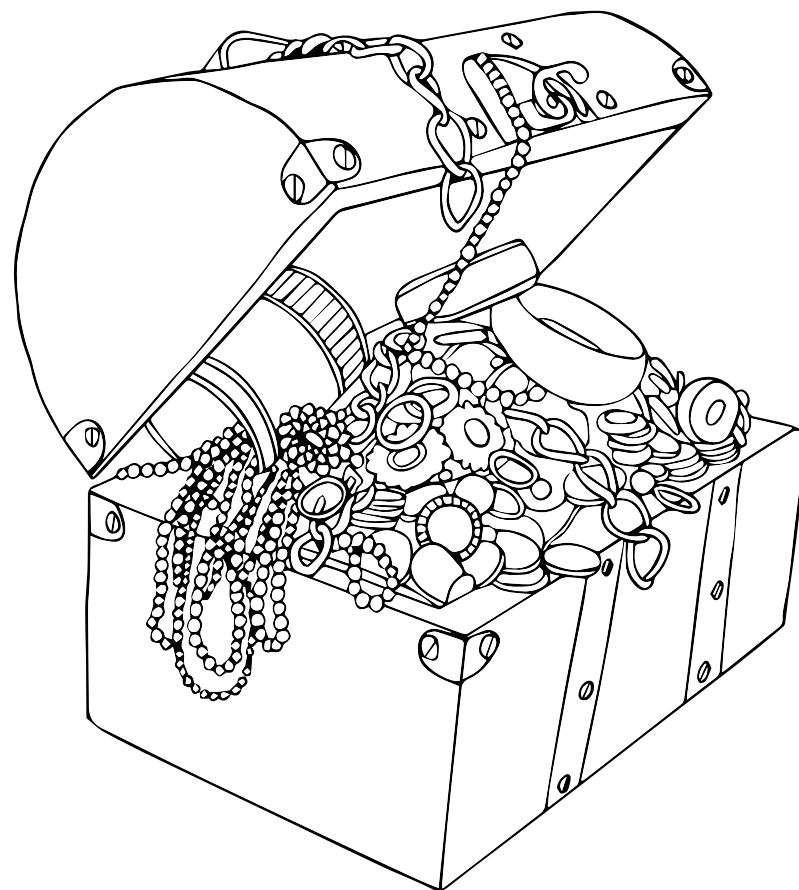

скарб  
poklad

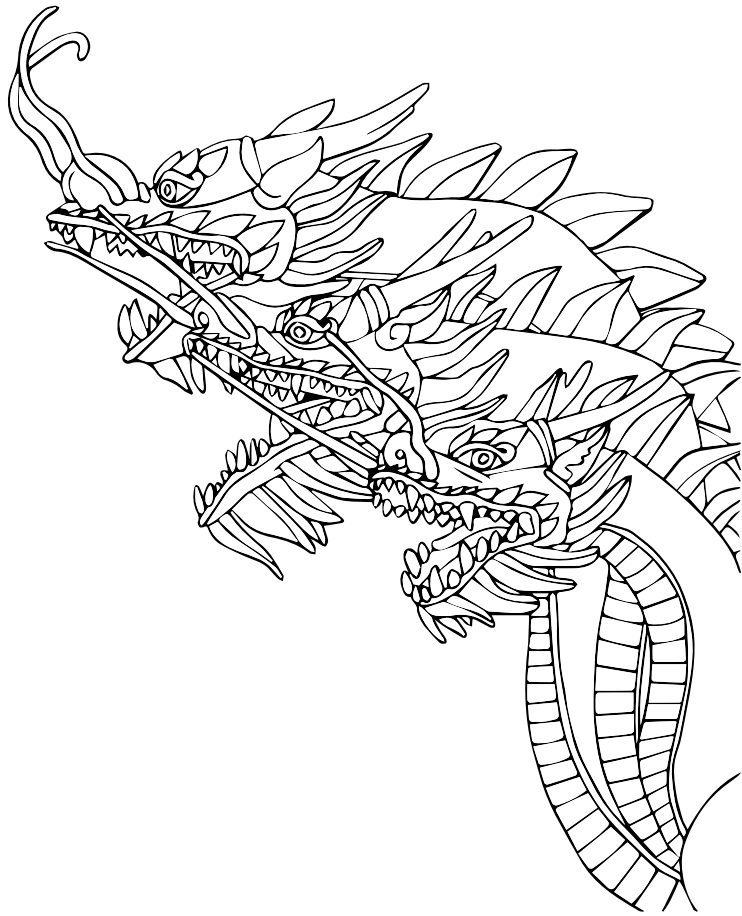

триголовий дракон  
trojhlavý drak



замок  
hrad

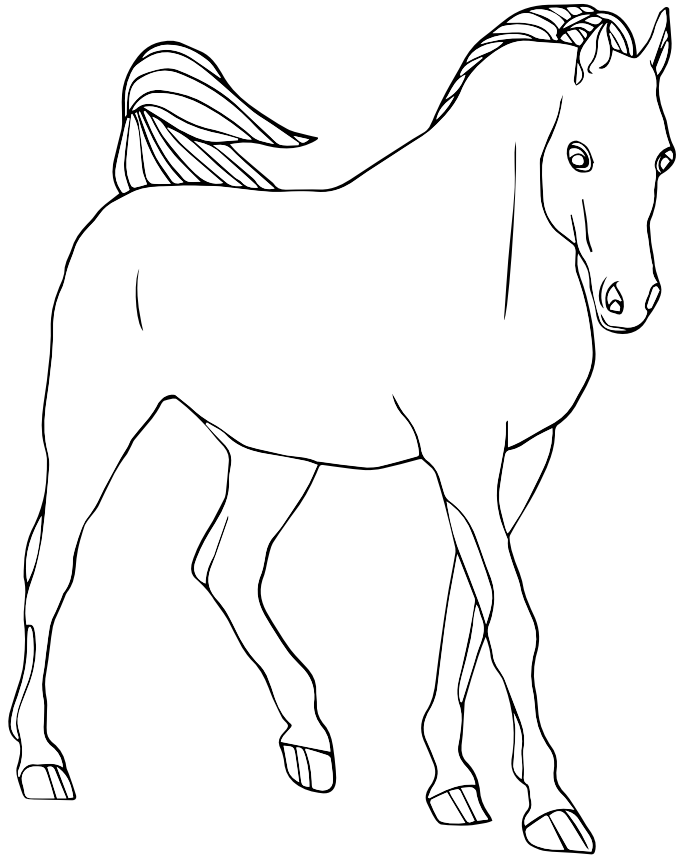

КІНЬ  
kôň



ГЛІНТВЕЙН  
varené víno

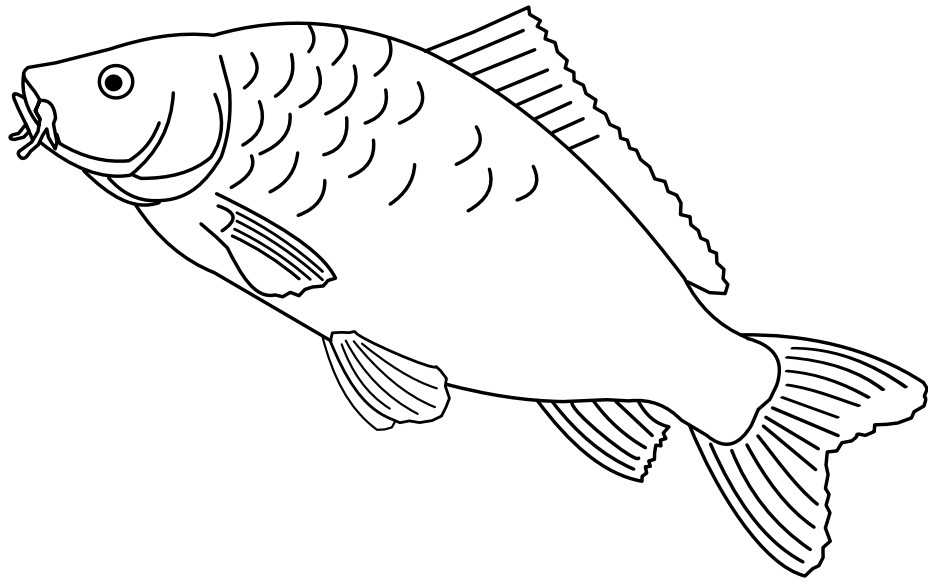

короп  
капор

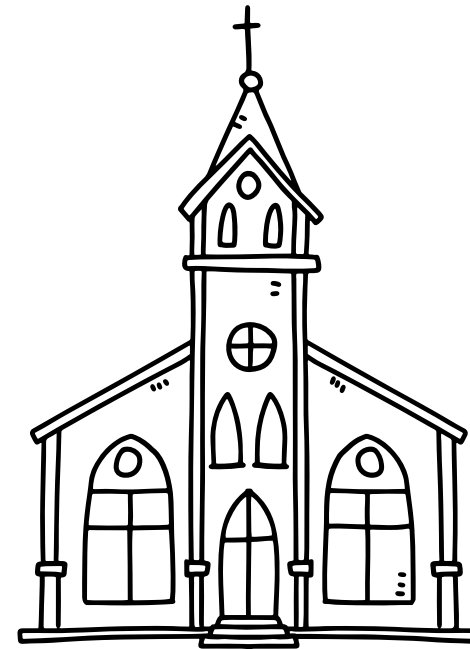

костел  
kostol

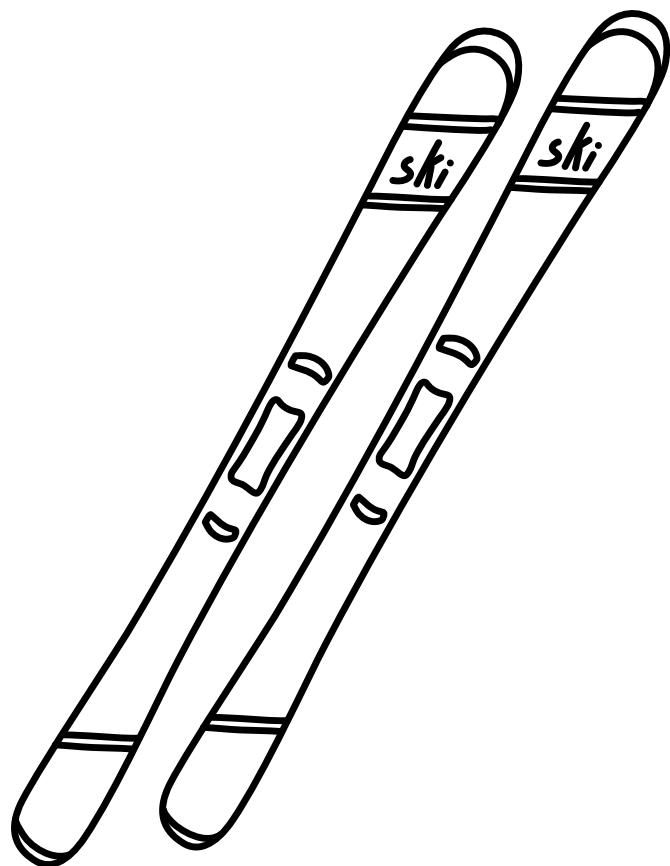

лижі  
lyže

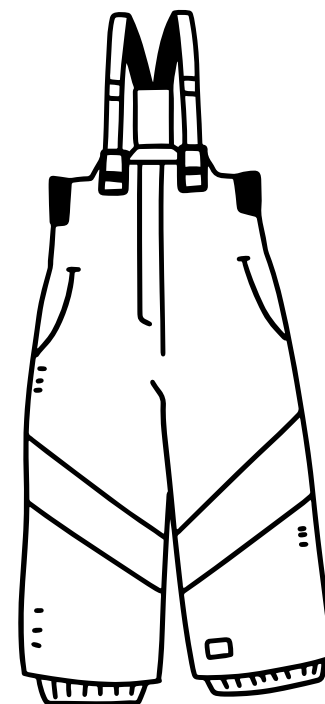

лижні штани  
otep'ovačky

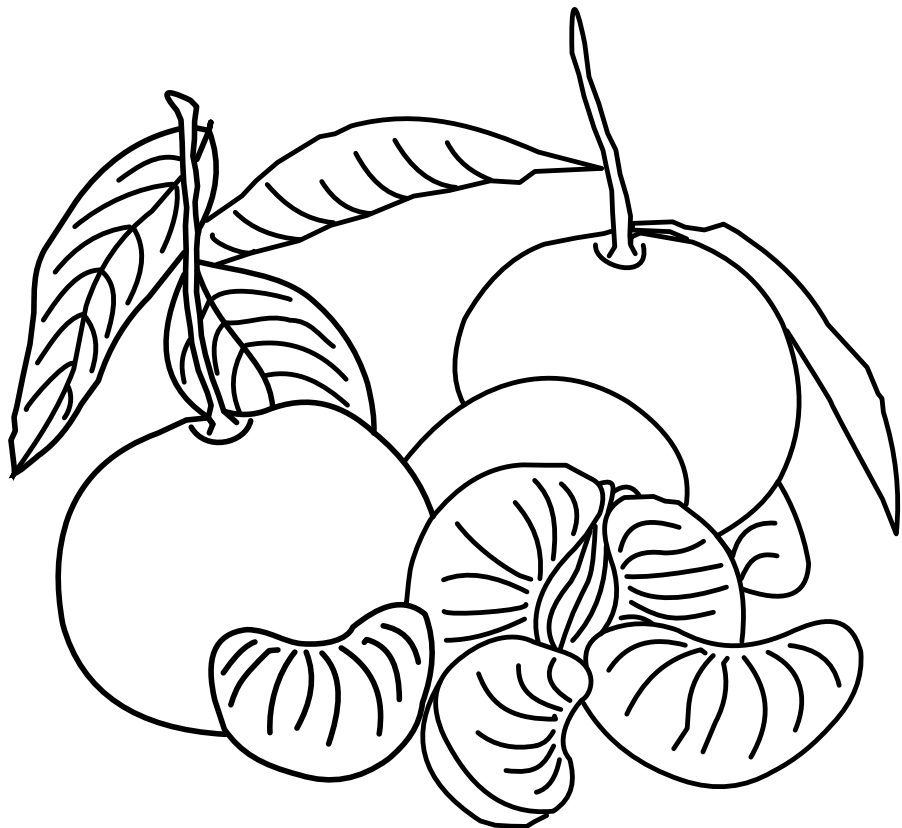

мандаринки  
mandarínky

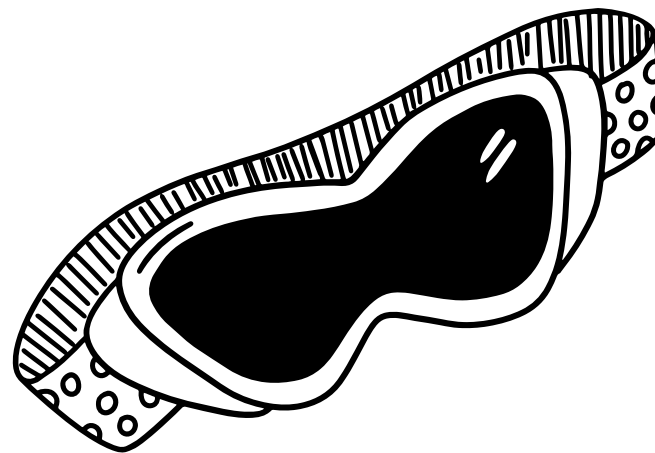

окуляри  
okuliare





омела  
imelo

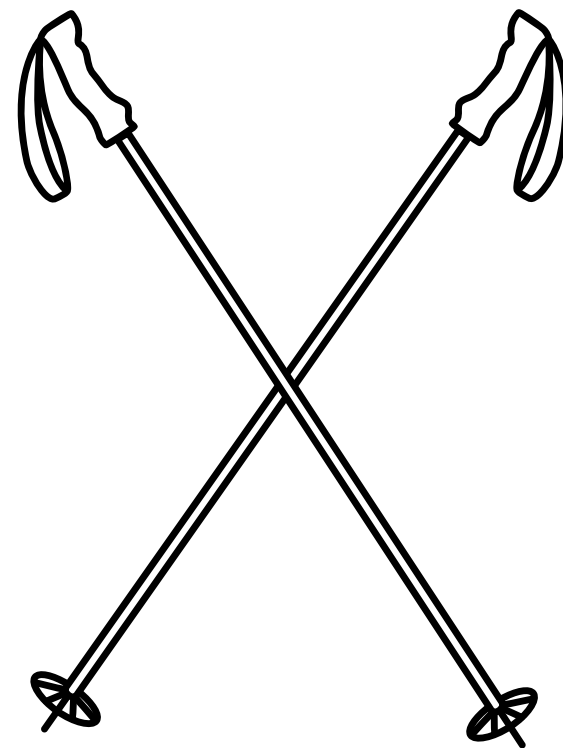

палки  
palice

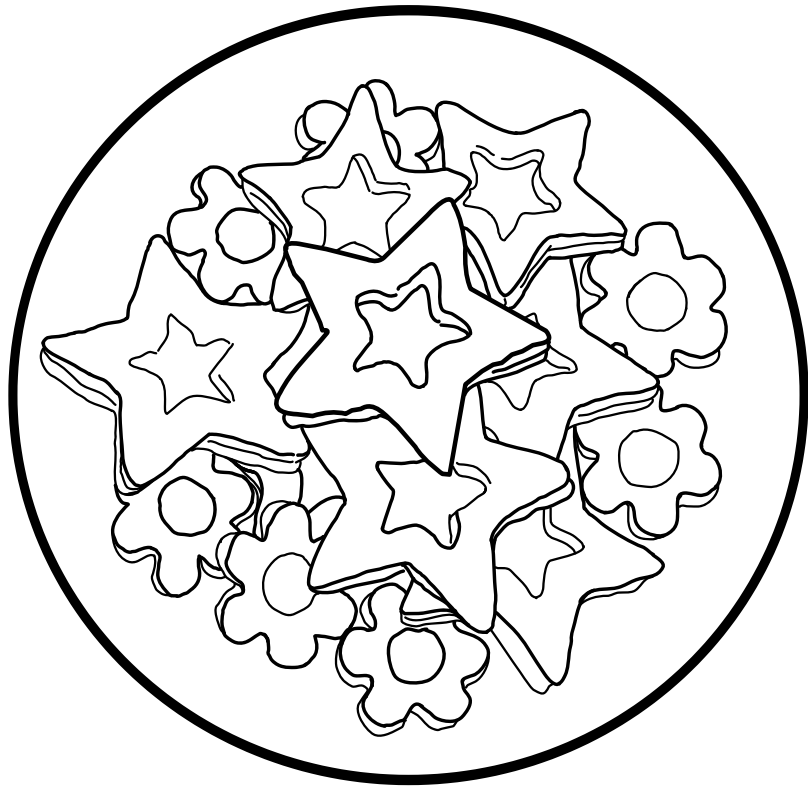

печиво з пісочного  
тіста  
linecké

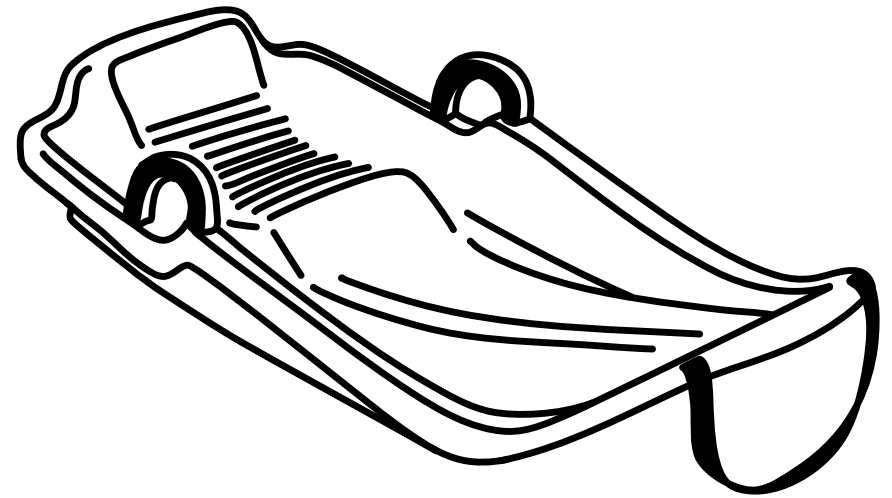

пластикові санчата  
boby



подарунок  
darček



прянички  
perníčky

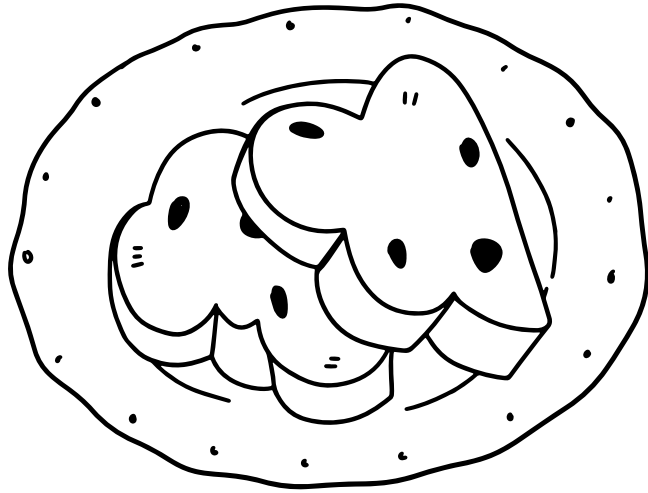

різдвяна булочка-  
плетінка  
vianočka

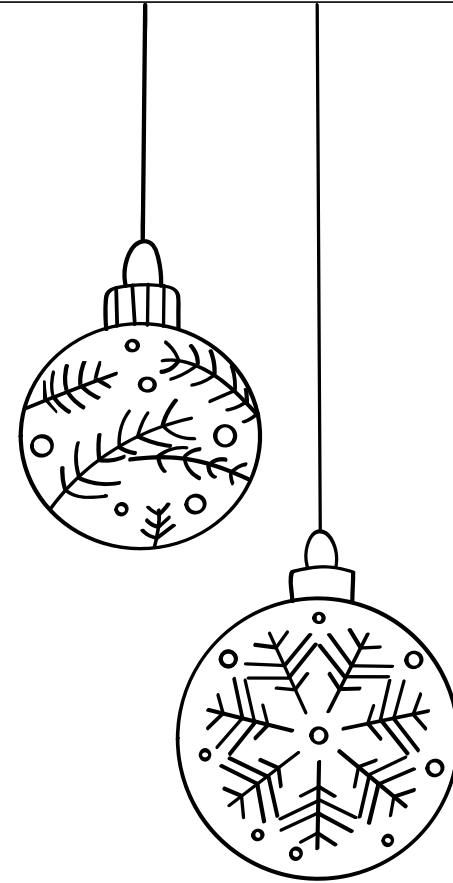

різдвяні прикраси  
vianočné ozdoby

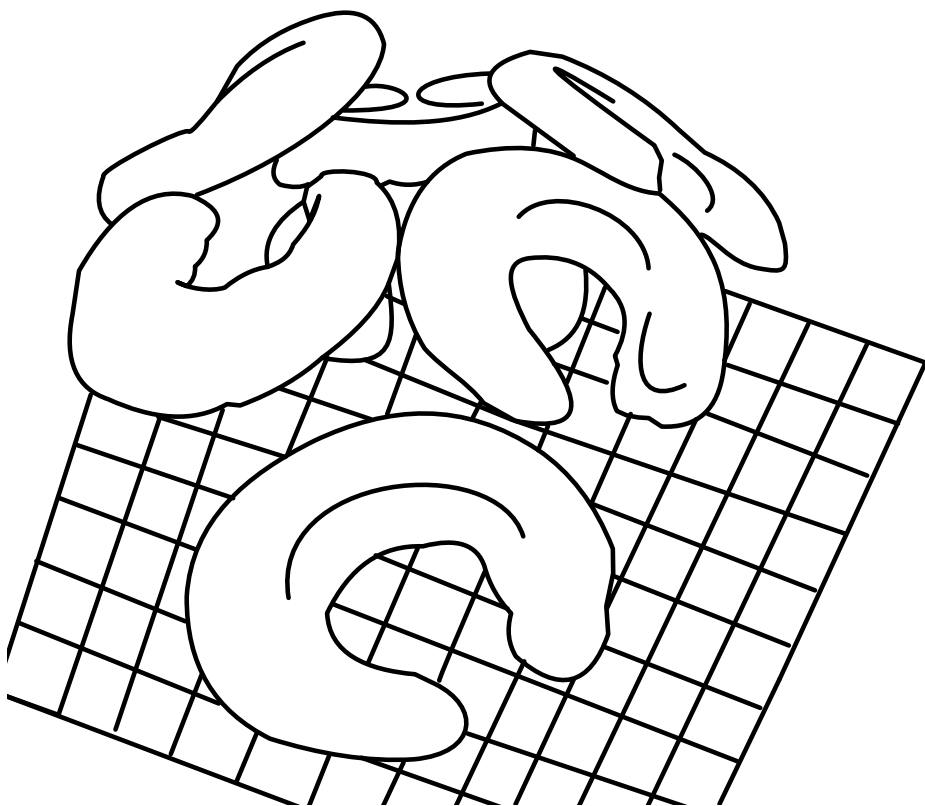

рогалики  
(vanilkové) rožky

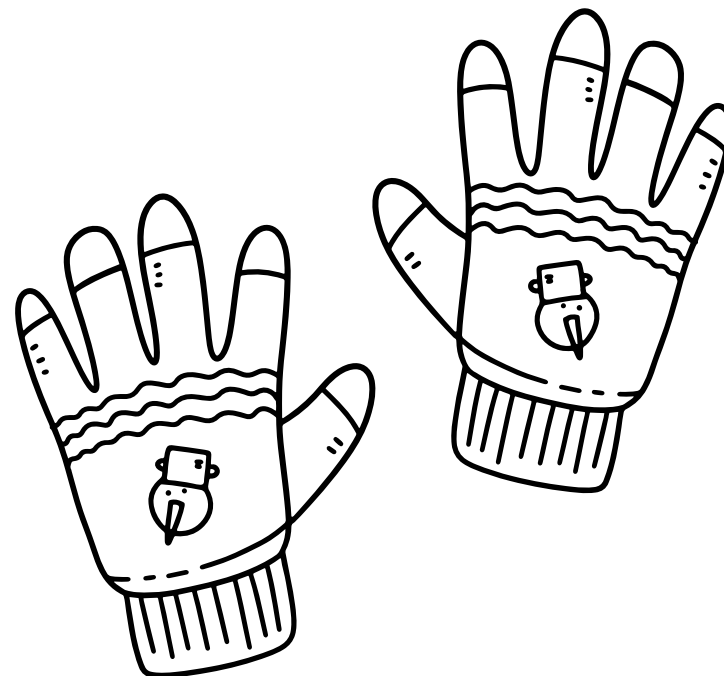

рукавиці  
rukavice

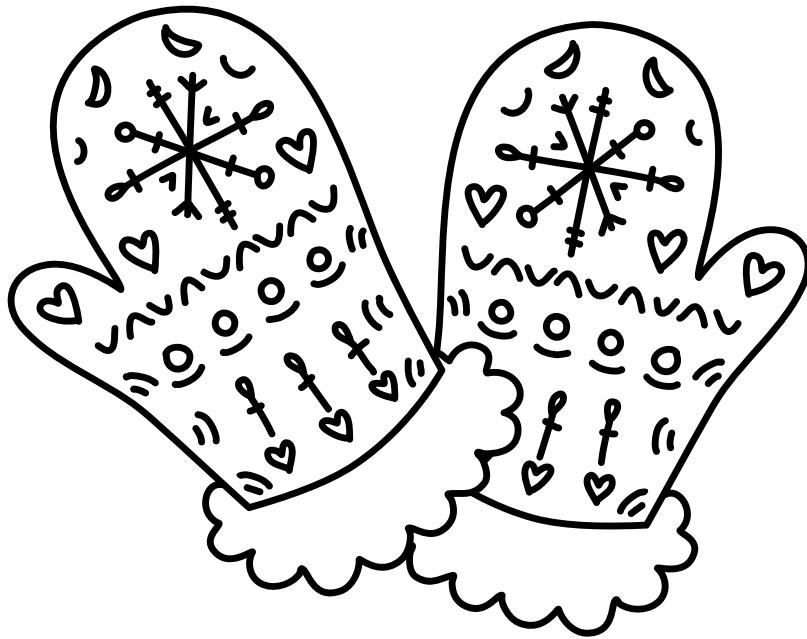

рукавиці (без  
пальців)  
paľčiaku

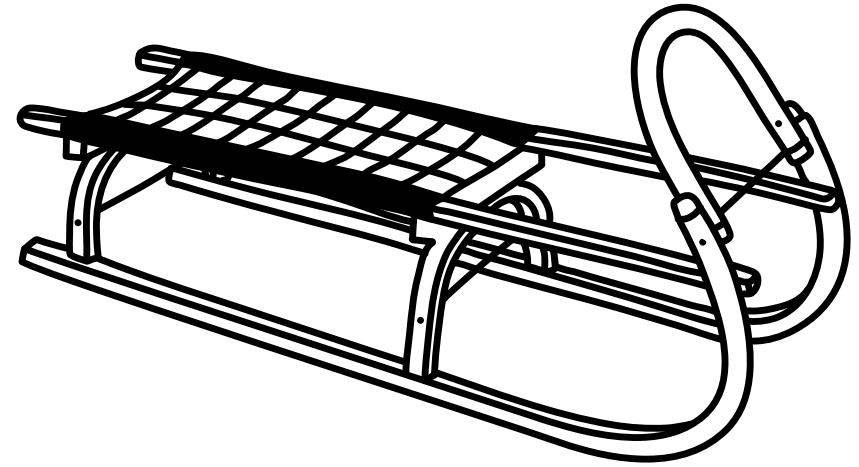

санчата  
sánky

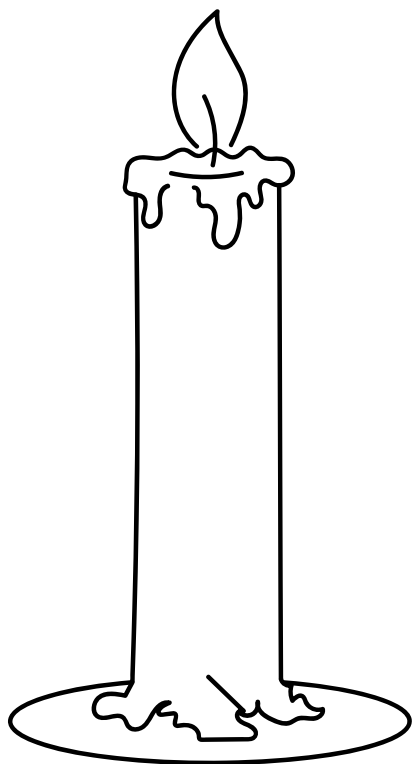

свічка  
sviečka

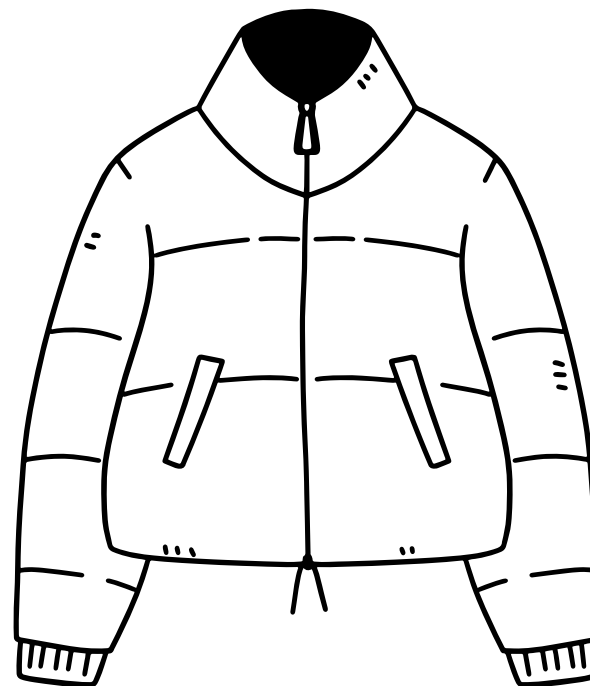

тепла куртка  
teplá bunda

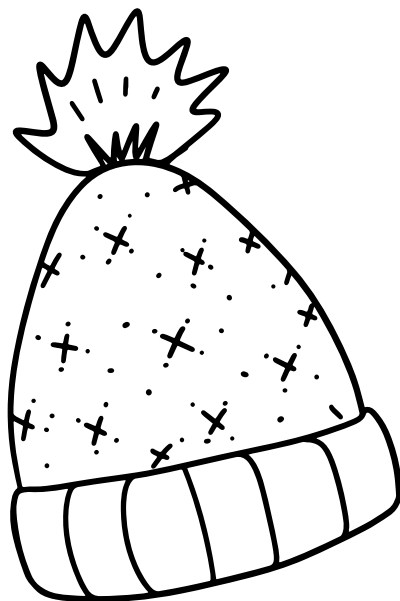

шапка  
čarica

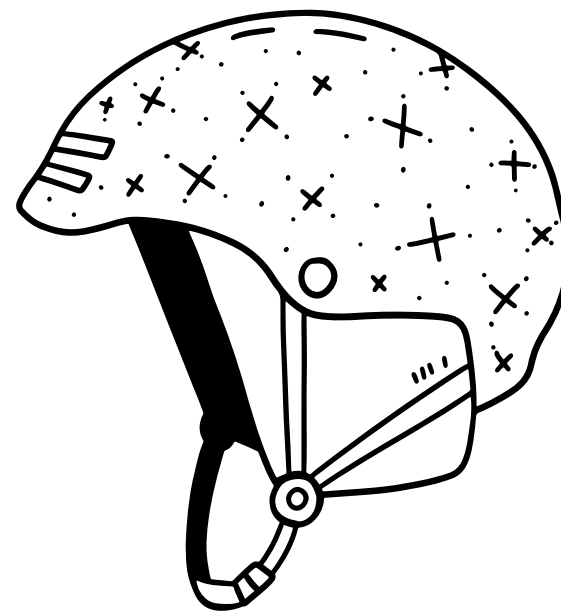

шолом  
helma, prilba



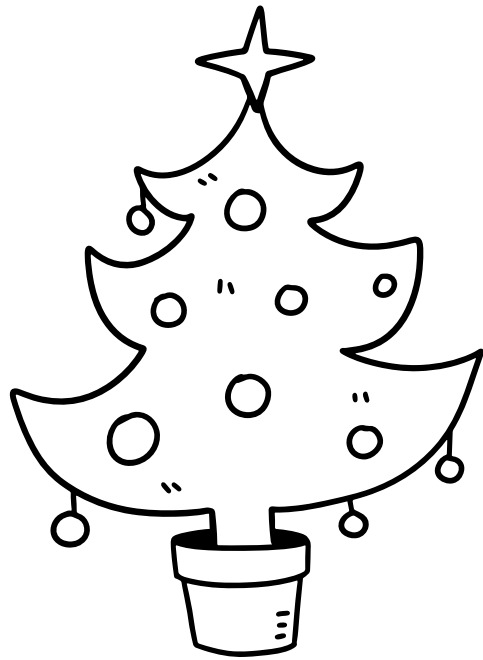

ялинка  
vianočný stromček



лижні черевики  
zjazdové lyžiarky